

{{1pagina-template-foto}}

Nanda / Up



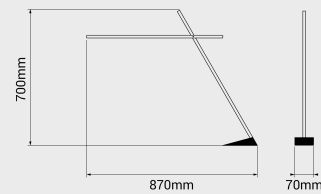
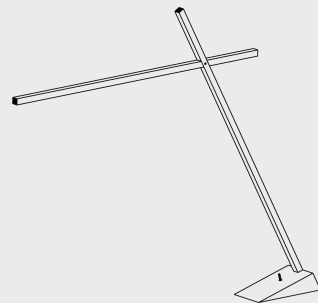

CVN000

Wall attachment
includes 2 single cleat E012

LED: 24 V | 10 W | 3000k | CRI >90 | 1270 lm
127 lm/W | > 50.000h | T 55°C
ALIMENTATORE: 24 V
CORPO: ottone tagliato al laser



Finishes

- | | |
|--|---|
|  OT: Brushed brass |  NI: Nickel |
|  BR: Bronze |  NE: Black |
|  RA: Copper | |

A++

LED

IP20

