

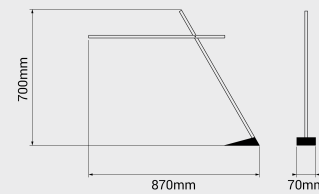

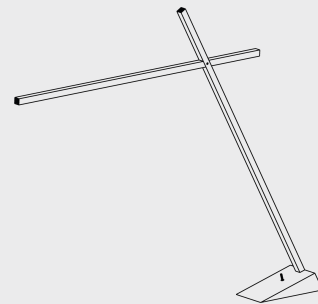



{{1pagina-template-foto}}



Finiture

	OT: Ottone spazz.		NI: Nichel
	BR: Bronzo		NE: Nero
	RA: Rame		

Nanda / Up

CVN000

Appoggio da TA
Doppia accensione: 100% 3200K e 50% 2700K

LED: 24 V | 10 W | 3000k | CRI >90 | 1270 lm
127 lm/W | > 50.000h | T 55°C
ALIMENTATORE: 24 V
CORPO: ottone tagliato al laser

A++

LED

IP20

