

{{1pagina-template-foto}}

**Sequenza Mini**



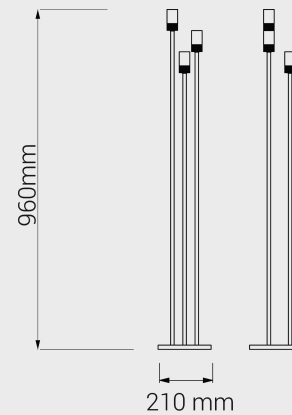
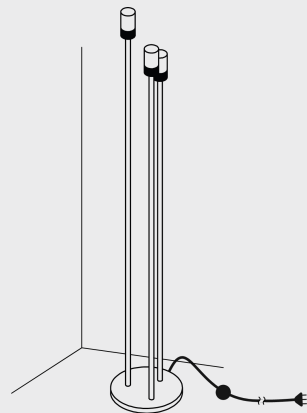

**SMI105**

Wall attachment  
includes 2 single cleat E012

LED: 3x2 W | 350 mA | 3000K | CRI 90  
996 lm | 166 lm/W | > 50.000h | T 55°C  
ALIMENTATORE: tensione costante 24 V  
220/240V | 50/60 Hz



**Finishes**

- |  |   |
|--|---|
|  <b>OT:</b> Brushed brass |  <b>NI:</b> Nickel |
|  <b>BR:</b> Bronze        |  <b>NE:</b> Black  |
|  <b>RA:</b> Copper        |   |

**Diffuser**

- |                                  |                                |
|----------------------------------|--------------------------------|
| <b>00:</b> Full transparent PMMA | <b>99:</b> Full vitrified PMMA |
|----------------------------------|--------------------------------|