

*invenso*  
LUCE D'AUTORE



**Sequenza Mini**

---

**SM750**



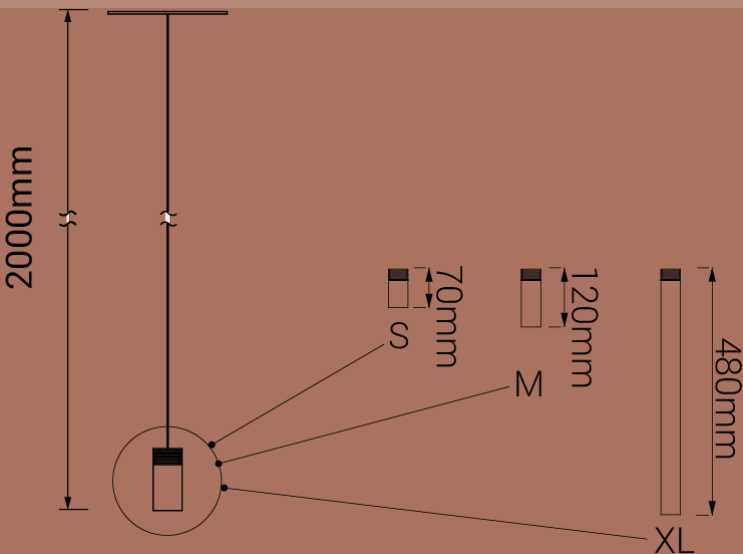

**Sequenza Mini**

**SM750**

Attacco plafone magnetico  
finitura nero o bianco (altre finiture su richiesta)

LED: 18x2 W | 350 mA | 3000K | CRI 90  
5976 lm | 166 lm/W | > 50.000h | T 55°C  
ALIMENTATORE: 350mA | 220/240V | 50/60 Hz  
Dimmer elettronico: 0/10-1-10-PUSH

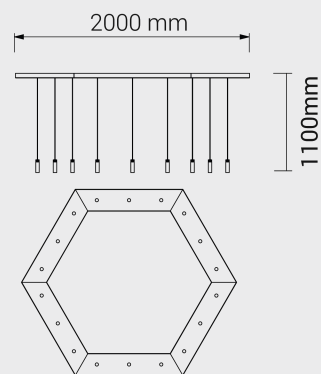
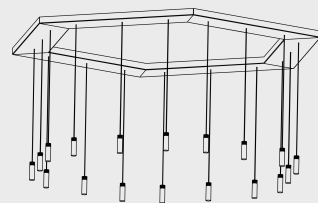

**Finiture**

- OT:** Ottone spazz.
- BR:** Bronzo
- RA:** Rame
- NI:** Nichel
- NE:** Nero

**Diffusore**

- 00:** PMMA trasparente pieno
- 99:** PMMA vetrificato pieno

**Accessori**

Dimmer elettronico: DALI

